

DIADE NO. 6

Wall Panel

INSTALLATION INSTRUCTIONS

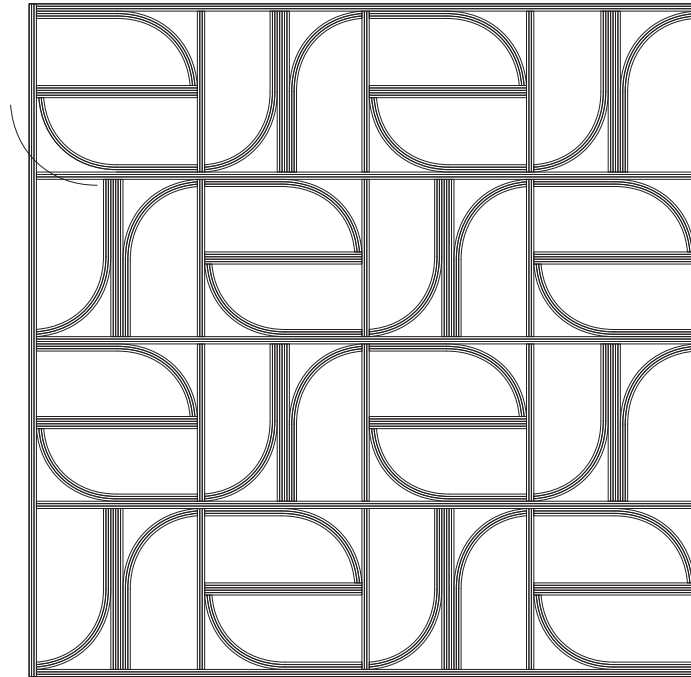

DESIGNER	Submaterial
PRODUCT NAME	Diade No. 6
PRODUCT NUMBER	SUMB-PANL-0038-01
FAMILY NAME	Diade
PRODUCT CATEGORY	Wall Panel
MATERIALS	100% Merino Wool Felt
INSTALLATION METHOD	French Cleat
PURPOSE	Residential, Interior use only
COLOR FASTNESS TO LIGHT	Felt, Class 4-5 (40 hours)
COLORFASTNESS TO CROCKING	Felt, Class 3-4 (wet), Class 4-5 (dry)
WARRANTY AND RETURNS	No warranties are offered on any Submaterial products. Most of our products are made to order, therefore we offer returns or exchanges due to manufacturer's defect only. Items must be returned in the original packaging and have no visible signs of wear or use. If you have a concern, please contact us within 3 business days of receipt of your products. Please retain the original packaging and wait for instructions from our sales team.

MINOR CLEANING

Like any natural fiber, you should always take a minimal approach to cleaning wool felt. The preferred steps taken for the cleaning process should consist of (in order of intensity): dusting with a lint roller, vacuuming with a clean soft brush, spot cleaning with water and mild detergent, using chemical stain removers. Periodic spot removal of lint can be achieved easily by using a standard tape lint roller. Once per year, it is recommended that the entire surface be given a light vacuum with a soft upholstery brush.

MAJOR CLEANING

For removal of minor stains, a mild enzyme-based detergent (such as Tide Free) is recommended. Create a dilute solution by adding three parts water to one part detergent in a clean container. **Always blot, never rub!** Use a clean paper towel to gently blot the detergent into the stain. Press and release; repeat. Using a separate container of water, use clean moist paper towels to blot more water into the stain. Press and release; repeat. Finish by blotting firmly with clean, dry paper towels until the area is nearly dry. There are many solvent-based spot removers available. Although we don't recommend them except in the case of emergency, the best choices for wool felt are dry cleaning fluids. Always test first in an inconspicuous area. Blot the stained area with a clean cloth soaked in dry cleaning fluid, then blot with clean cloth until dry.

DIADE NO. 6

Wall Panel

INSTALLATION INSTRUCTIONS

It is highly recommended two people work together for this installation procedure. Using very clean hands, handle the panel only by using the integrated wood cleat on the panel back, or by the edges. Never grab the panel by the felt face.

RECOMMENDED HARDWARE	
	Bar Level (at least 24")
	Tape Measure
	Power Drill
	1/8" Drill Bit
	Removable Tape
	Pencil

INCLUDED COMPONENTS	
	#8 - 1 5/8" Screws Wall Anchors



French Cleat

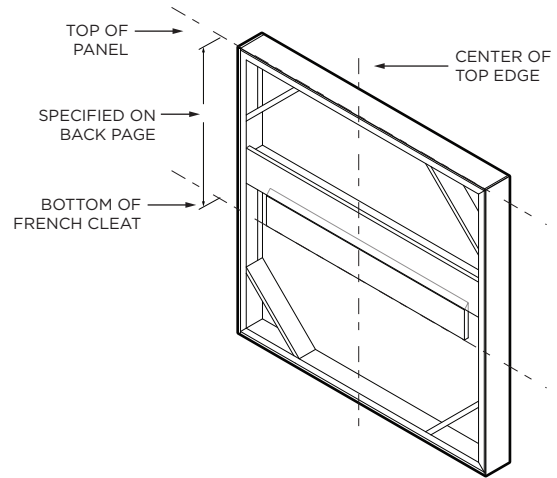
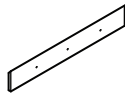

1. Determine the height where you wish your piece to be placed on the wall. Then using removable painters tape and a pencil mark the center of the top edge.
2. Using the distance written on the back of this pamphlet measure down from mark created in step one to create a mark where bottom of french cleat will be mounted.

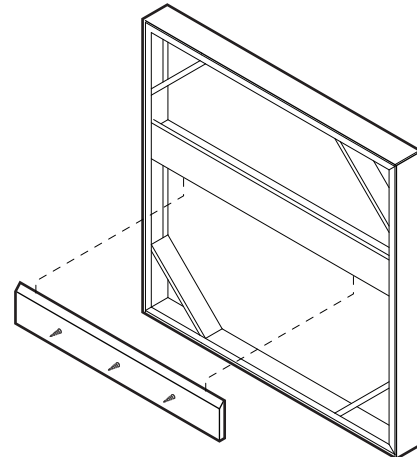
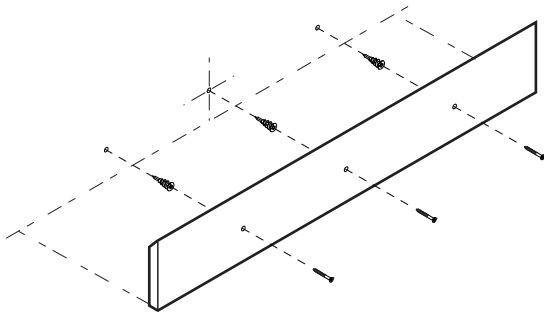

3. Raise bottom of french cleat to mark on wall and using bar level position French Cleat as true as possible. Once in place use pencil to mark drywall through holes drilled in French Cleats.
4. Lower cleat from wall then using a 1/8" drill bit drill holes though drywall on marks. Install drywall anchors.
5. Return French Cleat to original position and secure center screw using #8 - 1 5/8" screws provided - Do not tighten fully and do one final check for level - then fully secure all screws.

6. Raise panel to French Cleat on wall and lower to secure to opposing cleat on back of panel.
7. If minor adjustments are needed, the French Cleat can be shimmed using a small wad of paper, about the size of a grain of rice.
8. Inspect front of panel for disruptions in pattern and gently readjust.